



DS 210

Electronic Pressure Switch with Silicon Sensor

- ▶ 1 analogue output and up to 2 contacts
- ▶ display and housing rotatable
- ▶ nominal pressure ranges
from 0 ... 10 mbar
up to 0 ... 1 bar
and vacuum -1 ... 0 bar

The electronic pressure switch DS 210 is the successful combination of:

- precise pressure transmitter
- intelligent pressure switch
- digital display unit

Media to be measured can be gases, compressed air, as well as thin, non-aggressive liquids.

Compared to the universally used basic type DS 200, the DS 210 has a silicon sensor instead of a stainless steel sensor. Thus, the DS 210 is most suitable for pneumatics and vacuum technology, as well as for measurement of very small pressure. The system pressure is shown on the 4-digit LED display. In addition the display supports programming the DS 210 using the foil keys. Display and housing of the DS 210 are rotatable, so that the position of the display can be adapted to unusual installation positions.

The software has several functions such as access protection, configuration of the display and the contacts, etc. Set and reset points are freely configurable in the range 0 to 100 % of nominal pressure.

- ▶ configuration of display, including
 - current value
 - decimal point
- ▶ contact adjustable including
 - switch on / switch off point
 - hysteresis / window mode
 - switch on / switch off delay
- ▶ special functions / administration
 - access protection
 - min. / max. value memory
- ▶ option Ex-version (only for 4 ... 20 mA / 2-wire)
TÜV 02 ATEX 1841

Functions



DS 210
Electronic Pressure Switch

Input pressure range											
Nominal pressure gauge [mbar]	-1000 ... 0	10	20	40	60	100	160	250	400	600	1000
Permissible overpressure[mbar]	3000	60	60	300	300	300	1000	1000	1000	3000	3000

Output signal / Supply			
Analogue output			
Standard	2-wire: 4 ... 20 mA / $V_s = 18 \dots 41 V_{DC}$	Ex-protection: $V_s = 17 \dots 28 V_{DC}$	
Optional	3-wire: 0 ... 10 V / $V_s = 15 \dots 36 V_{DC}$	4 ... 20 mA / $V_s = 19 \dots 30 V_{DC}$ (on request)	
Accuracy	standard: nominal pressure > 100 mbar: nominal pressure ≤ 100 mbar	IEC 60770 ¹	BFSL
		≤ ± 0.35 % FSO ≤ ± 0.50 % FSO	≤ ± 0.175 % FSO ≤ ± 0.250 % FSO
Permissible load	current 2-wire: $R_{max} = [(V_s - V_{s min}) / 0.02] \Omega$ voltage 3-wire: $R_{min} = 10 k\Omega$		
Response time	< 5 msec ²		
Contact ^{3,4}			
Number, type	1 or 2 independent PNP contacts		
Switching current	standard: contact rating max. 125 mA, short-circuit resistance Ex-protection: max. switching current ⁵ : 70 mA; max. permissible inductivity: 4.7 mH		
Accuracy of contacts	standard: nominal pressure > 100 mbar: nominal pressure ≤ 100 mbar	IEC 60770 ¹	BFSL
		≤ ± 0.35 % FSO ≤ ± 0.50 % FSO	≤ ± 0.175 % FSO ≤ ± 0.250 % FSO
Repeatability	≤ ± 0.1 % FSO		
Switching frequency	max. 10 Hz		
Switching cycles	> 100 x 10 ⁶		
Delay time	0 ... 100 sec		

Thermal errors (Offset and Span)				
Nominal pressure P_N	-1000 ... 0 mbar	≤ 100 mbar	≤ 400 mbar	> 400 mbar
Tolerance band	≤ ± 0.75 % FSO	≤ ± 1.5 % FSO	≤ ± 1 % FSO	≤ ± 0.75 % FSO
TC, average	0.08 % FSO / 10 K	0.15 % FSO / 10 K	0.12 % FSO / 10 K	0.08 % FSO / 10 K
in compensated range	0 ... 60 °C			

Electrical protection	
Short-circuit protection	permanent
Reverse polarity protection	no damage, but also no function
Electromagnetic compatibility	emission and immunity according to EN 61326
Option Ex-protection only for 4 ... 20 mA / 2-wire AX11-DS 210	zone (0) 1: II (1) 2 G EEx ia IIC T4 safety technical maximum values: $V_i = 28 V$, $\Sigma I_i = 93 mA$, $\Sigma P_i = 660 mW$

Display	
Type	4-digit, red LED display, digit height 7 mm, digit width 4.85 mm (angle 10 °)
Range	-1999 ... +9999
Accuracy	0.1 % ± 1 digit
Digital damping	0.3 ... 30 sec (programmable)
Measured value update	0.0 ... 10 sec (programmable)

¹ accuracy according to IEC 60770 – limit point adjustment (non-linearity, hysteresis, repeatability)

² with 3-wire version 4 ... 20 mA the response time is 1 sec

³ with connector DIN 43650 and output 4 ... 20 mA / 2-wire max. 1 contact possible; with 0 ... 10 V / 3-wire no contact possible

⁴ with Ex-protection max. 1 contact possible

⁵ the real switching current in the application depends on the power supply unit

DS 210

Electronic Pressure Switch

Technical Data

Mechanical stability

Vibration	5 g RMS (20 ... 2000 Hz)
Shock	100 g / 11 msec

Permissible temperatures

Medium	-25 ... 90 °C	
Electronics / environment	-25 ... 85 °C	Ex-protection: -25 ... 70 °C
Storage	-40 ... 85 °C	

Mechanical connection

Standard

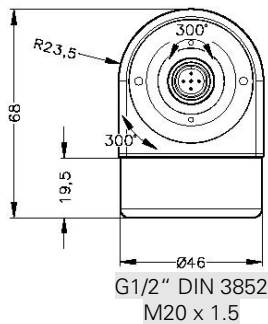
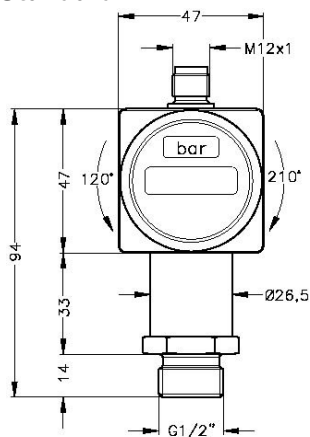

Optional

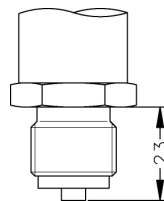

G1/2" EN 837
M20 x 1.5

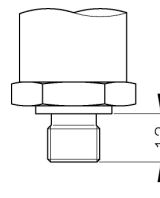

G1/4" DIN 3852
M10 x 1
M12 x 1
M12 x 1.5

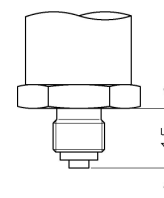

G1/4" EN 837

⇒ Ex protection: total length increases by 26.5 mm!

Electrical connection

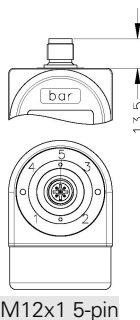

M12x1 5-pin

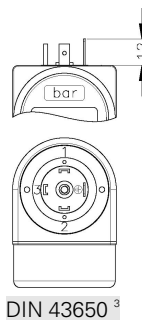

DIN 43650³

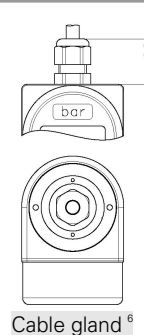

Cable gland⁶

⁶ different cable types and lengths available; standard: 2 m PVC cable without ventilation tube, optionally cable with ventilation tube

Materials

Pressure port	stainless steel 1.4571 (316Ti)
Housing	stainless steel 1.4301 (304)
Display housing	PA 6.6, Polycarbonate
Seals (media wetted)	FKM
Sensor	stainless steel 1.4305 (303) , RTV, ceramics Al_2O_3 , silicon
Media wetted parts	pressure port, seals, sensor

Miscellaneous

Current consumption (without contacts)	signal output current: max. 25 mA signal output voltage: max. 18 mA
Weight	approx. 180 g
Installation position	any
Ingress protection	IP 65

Pin configuration

Electrical connection		M12x1 plastic (5-pin)	M12x1 metal (5-pin)	DIN 43650	cable colours (DIN 47100)
2-wire-system	Supply +	1	1	1	white
	Supply -	3	3	2	brown
	Contact 1	4	4	3	grey
	Contact 2	5	5	-	pink
	Ground	via pressure port	plug housing	ground contact	yellow / green (shield)
3-wire-system	Supply +	1	1	1	white
	Supply -	3	3	2	brown
	Signal +	2	2	3	green
	Contact 1	4	4	-	grey
Contact 2	5	5	-	pink	
	Ground	via pressure port	plug housing	ground contact	yellow / green (shield)

Wiring diagrams

2-wire-system (current) (for Ex-protection: supply $V_s = 17 \dots 28 V_{DC}$; max. 1 contact possible)

without contact

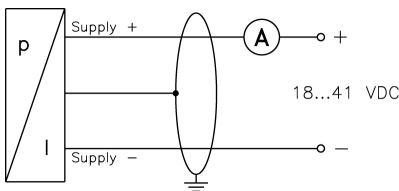

1 contact

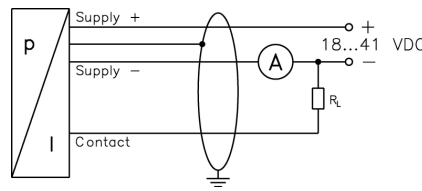

2 contacts

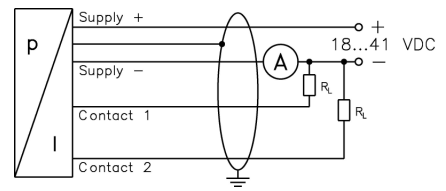

3-wire-system (voltage)

without contact

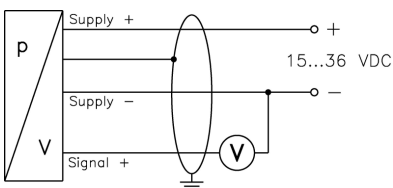

1 contact

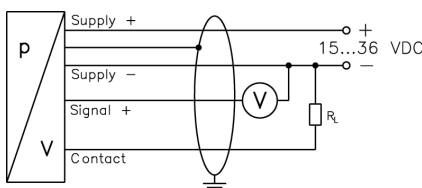

2 contacts

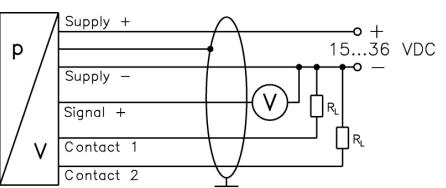

This data sheet contains product specification, properties are not guaranteed. Subject to change without notice.

Ordering Code DS 210

DS 210

□□□ - □□□□ - □ - □ - □ - □□□ - □□□ - □ - □□□

Pressure			
gauge	7	8	A
Input			
[mbar]			
10	0	1	0 0
20	0	2	0 0
40	0	4	0 0
60	0	6	0 0
100	1	0	0 0
160	1	6	0 0
250	2	5	0 0
400	4	0	0 0
600	6	0	0 0
1000	1	0	0 1
-1000 ... 0	X	1	0 2
customer	9	9	9 9
Analogue output			
4 ... 20 mA / 2-wire			1
0 ... 10 V / 3-wire			3
4 ... 20 mA / 3-wire			7
Intrinsic safety 4 ... 20 mA / 2-wire ¹			E
customer			9
Contact			
1 contact ^{1,2}			1
2 contacts ^{1,2}			2
Accuracy			
standard for P _N > 0,1 bar	0,35 %		3
standard for P _N ≤ 0,1 bar	0,5 %		5
customer			9
Electrical connection			
M12x1 (5-pin) / plastic version		N	0 0
M12x1 (5-pin) / metal version		N	1 0
Male and female plug DIN 43650 ²		1	0 0
Cable gland incl. Cable ³		4	0 0
customer		9	9 9
Mechanical connection			
G1/2" DIN 3852		1	0 0
G1/2" EN 837		2	0 0
G1/4" DIN 3852		3	0 0
G1/4" EN 837		4	0 0
customer		9	9 9
Seals			
FKM			1
customer			9
Special version			
standard			0 0 0
customer			9 9 9

¹ with Ex version max. 1 contact is possible
² with connector DIN 43650 and output 2-wire version only max. 1 contact possible; with 3-wire version no contact possible
³ different cable types and lengths deliverable, standard: 2 m PVC cable without ventilation tube, optionally cable with ventilation tube

This ordering code contains product specification; properties are not guaranteed. Subject to change without notice.

